

June 2021

Epson EB-PU2000/1000 series

Take Image Quality to New Levels With Epson's Game Changing Laser Projector



For further information please visit www.channel.epson.com.au



KEY FEATURES:

- **NEW Up to 10,000 Lumens** - Deliver captivating images in virtually any venue
- **Laser Light Source** - Experience astonishing quality and reliability
- **Up to 3x Brighter Colour and Reliable Performance¹** - 3LCD, 3-chip technology
- **2,500,000:1 Contrast Ratio** - For lifelike images and remarkable detail in dark scenes
- **4K Enhancement** - Go beyond High Definition with 4K enhancement and native WUXGA (1920 x 1200) resolution for presentations, videos, digital signage and more
- **NEW High Dynamic Range** - Faithfully reproduce HDR content for an exceptional visual performance
- **NEW Gamma Correction** – Automatically adjusts the image based on scene images frame by frame for optimum contrast
- **NEW NFC** feature & **NEW Epson Configuration Tool App** – Collect essential projector information by simply tapping a mobile phone on the back of projector
- **NEW High-Performance Options** – External high capacity air filter ELPAF63 and light weight ceiling mount ELPMB67 and extension pole ELPFP15
- **NEW External Camera** – ELPEC01 automatically calibrates image with Epson Professional Tool software
- **NEW SDI In & Out** – Daisy chain ability allows the simplest stacking without requiring an additional PC or a splitter (SDI connectivity is only available on EB-PU2010B/W)
- **NEW Art-net Support** – Synchronise image brightness with the stage and theatre lighting effects.
- **Professional Tool** - Efficiently setup multiple projectors straight out of the box with new large venue application software
- **Colour Uniformity** - Keep images consistent and maintenance to a minimum with automatic colour correction (automatic calibration is supported only with ELPEC01)
- **Edge Blending** - Combine multiple individual images to create one seamless giant image
- **Wireless LAN Enterprise Security** - Connect projectors in a secure wireless network environment
- **HDBaseT** - Transmit Full HD video and audio, Ethernet and Serial communication through a single CAT 5/6 cable that can be extended up to 100m
- **360° Installation** - Install on any plane, from horizontal to vertical and everything in-between
- **Powered Lens Shift, Zoom and Focus** - Project perfectly uniform images with a new stepping motor and store up to 10 lens settings
- **Eleven Optional Lenses²** - Choose the ideal powered lens for your venue from a wide range including ultra-short throw and long throw
- **Content Playback** - Create engaging digital experiences with Epson content management software and playback contents saved on USB drive.
- **5 Years Projector Warranty³** - A class leading 20,000 hour or 5 year warranty

¹Colour brightness (colour light output) in brightest mode, measured by a third-party lab in accordance with IDMS 15.4. Colour brightness will vary depending on usage conditions. Top-selling Epson 3LCD projectors versus top-selling 1-chip DLP projectors based on PMA Research sales data for May 2017 through April 2018.

²Please refer to lens compatibility chart

³Whichever occurs first, see www.epson.com.au for full warranty terms and conditions.

3LCD Technology

All Epson projectors are based on 3-chip LCD technology for amazing colour, incredible detail and solid reliability. 3LCD's 3-chip architecture dedicates an entire chip to process each primary colour – red, green and blue, continuously. Unlike single-chip technology that delivers colour sequentially, you get full-time colour. The result is vibrant, realistic images and video all delivered with 3LCD's true-to-life colour.



Up to 3x Brighter Colours with Epson Projectors*



Epson projectors use 3LCD Engines that have no colour wheel with a white segment and therefore don't force a tradeoff between white and colour brightness.

In fact, Epson projectors have up to 3x Brighter Colours than their leading competitive 1-chip DLP projectors*. All Epson projectors list both White Brightness and Colour Brightness specifications, and all have high Colour Brightness.

*Colour brightness (colour light output) in brightest mode, measured by a third-party lab in accordance with IDMS 15.4. Colour brightness will vary depending on usage conditions. Top-selling Epson 3LCD projectors versus top-selling 1-chip DLP projectors based on PMA Research sales data for May 2017 through April 2018.

Laser Light Source

Experience astonishing quality and reliability with Epson's new laser light source. The newly designed laser light source and advanced electrostatic filter deliver 20,000 hours of maintenance-free use and consistent performance for total peace of mind during important presentations.



NEW Up to 10,000 lumens

Powered by 3LCD technology and Epson's laser optical engine, the EB-PU2000/1000 series is capable of producing White Light and Colour Light Output of up to 10,000 lumens in WUXGA resolution, delivering captivating images in virtually any venue.

The laser light source also lets you take control of brightness with precise adjustment in increments of 1% and a constant brightness mode that maintains brightness at a specified level.



For further information please visit www.channel.epson.com.au



4K Enhancement

The EB-PU2000/1000 series delivers high-precision images with 4K Enhancement (4KE) technology. Upscale 1080p content with 4KE, which shifts pixels diagonally by 0.5 pixels to double the resolution, for crisp and high-definition images.

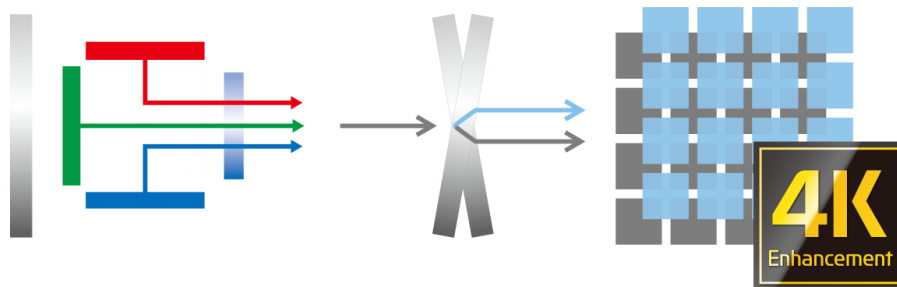

Deep Black Contrast

The EB-PU2000/1000 series delivers deep black contrast ratios up to 2,500,000:1. With Epson's innovative laser light source, you get remarkably high contrast levels during full-black scenes. A special optical device is used to adjust polarization and reproduce truly dark shades of black for projection venues that require the most deep black such as theatres.

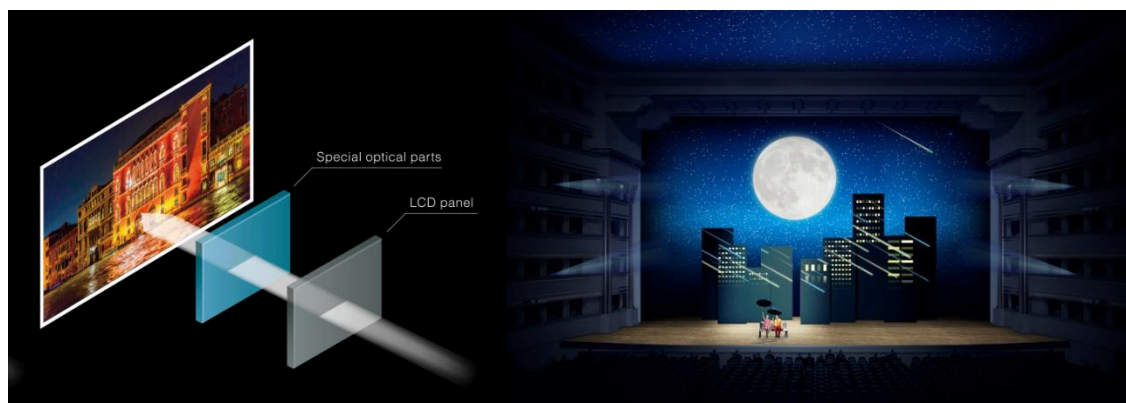

NEW High Dynamic Range

The EB-PU2000/1000 series supports HDR10 and Hybrid Log-Gamma, which expands dynamic range for image output across a broad tonal range and minimises washed-out highlights or excessive shadow in dark areas.

SDR (standard dynamic range)



HDR (high dynamic range)



NEW Scene Adaptive Gamma Correction

Gamma level is adjusted automatically according to the content image frame-by-frame, projecting the optimum contrast level. By controlling crushed blacks in dark scenes and clipped whites in bright scenes, images can be displayed in the most natural and life-like manner.

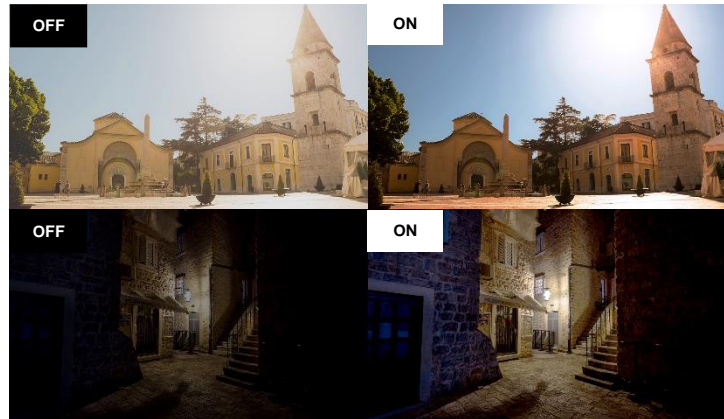

ADVANCED INSTALLATION FEATURES

Powerful and Compact

The EB-PU2000/1000 series can deliver upto 10,000 lumens of brightness in a compact size*. Approximately 25% smaller and lighter than Epson's L series projectors, transporting and setup process has become much easier, and loading weight has become much lighter when projectors get shipped to shows and events.

**Weight: 16.8kg (excluding lens), Dimension D x W x H: 436 x 545 x 164mm (excluding lens, cable cover and feet)*

**25% smaller
and lighter***
than the traditional model



Powered Lens Shift, Zoom and Focus

The motorised lens shift covers a wide range, giving you a great deal of flexibility when installing the projector. A newly adopted stepping motor lets you make highly precise adjustments when employing edge blending, stacking and other techniques. Adjustments can be made via remote control or over a network, enhancing usability even for ceiling-mounted projectors.

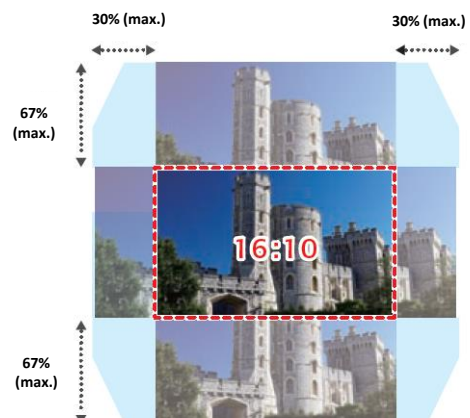

Lens shift range*

**±67% vertically, ±30% horizontally for EB-PU1000 series with ELPLM08*

**±60% vertically, ±18% horizontally for EB-PU2000 series with ELPLM15*

For further information please visit www.channel.epson.com.au



NEW SDI In/Out Signal

The EB-PU2000 series is equipped with SDI (in/out) signal*, stacking of two projectors can be done without requirement of PC or Wi-Fi router. Conveniently project up to 20,000 lumens of brightness with two EB-PU2000 series in large venues using the built-in daisy chain function‡. Simply connect two projectors with a LAN cable and trigger the function with remote command to setup within 7 minutes**.

**SDI in & out connectivity is only available on EB-PU2010W and EB-PU2010B.*

‡Daisy chain function is limited to connecting 2 projectors only.

***ELPEC01 external camera is required to achieve installation within 7 minutes. Combining with EPPT software, automatic stacking process reduces setup time to 5 minutes.*

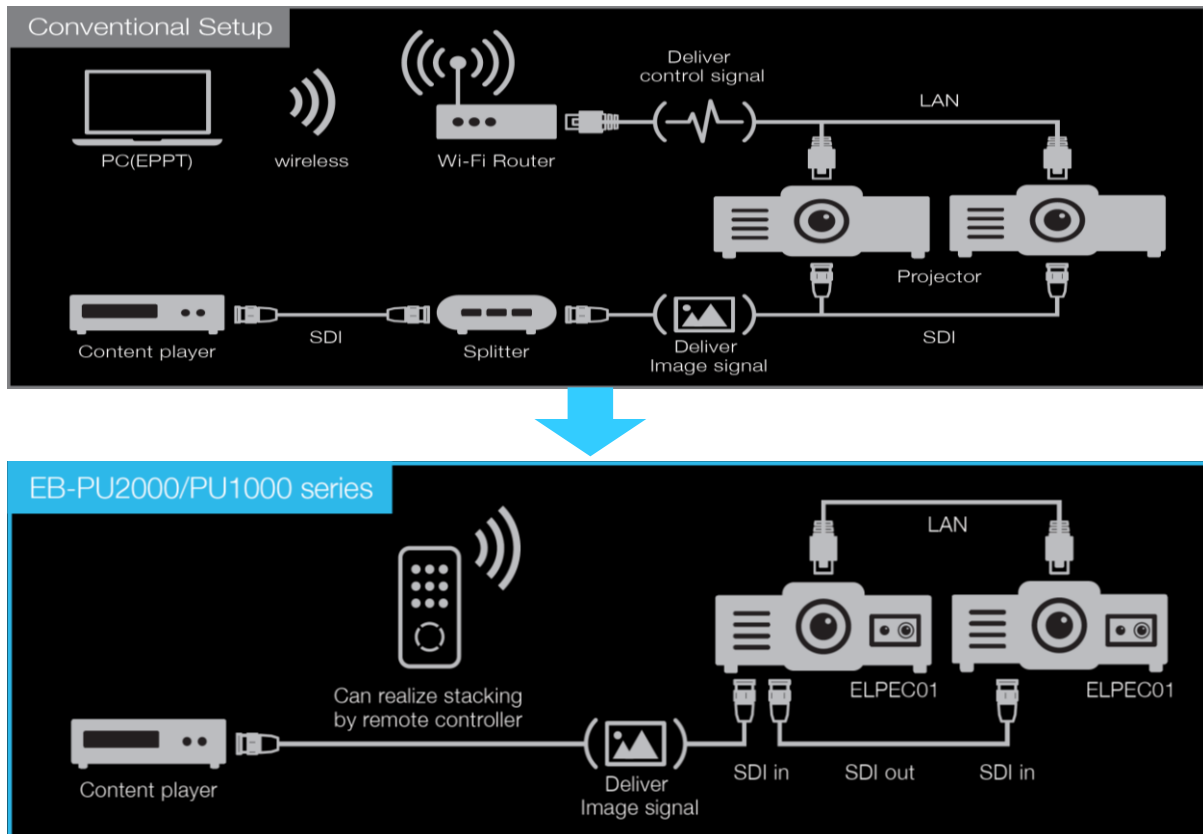

Multi-directional Projection

The EB-PU2000/1000 series can be rotated 360° in any direction — horizontally, vertically and diagonally — ideal for a wide range of applications, such as ceiling or floor projection.



Lens Position Memory

Up to 10 settings can be stored in the projector memory, including shift positions, focus and projection sizes.

For further information please visit www.channel.epson.com.au



Scaling

Make the most of the image content's native aspect ratio using a scaling feature built-in to the EB-PU2000/1000 series. Without requiring a supercomputer, source content from a splitter output can be recombined automatically using the scaling feature of two projectors.

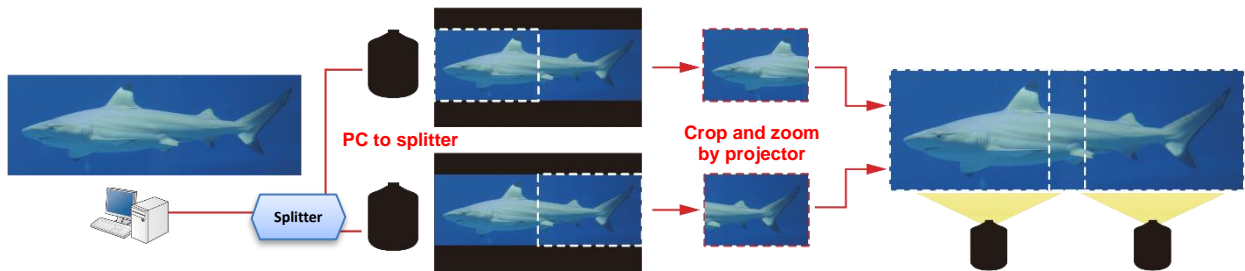

NEW Art-Net Lighting Control System

The EB-PU2000/1000 series supports Art-Net lighting control systems, making the projector ideal for use in live performances in stage or theatre. Control the projector with an Art-Net compatible lighting desk or control system to synchronise with in-house lighting effects. Image brightness can be controlled as low as 8% to the maximum 100%, giving ultimate fade-in and fade-out effects for stage and theatre shows and performances.

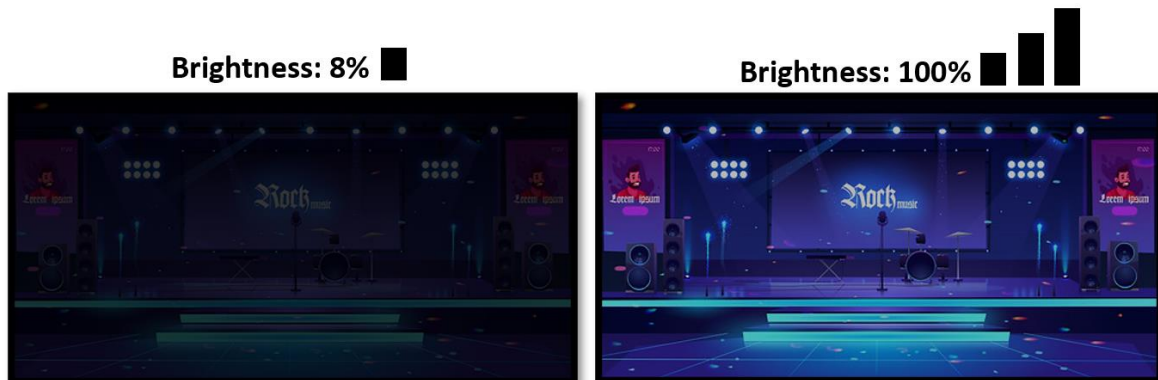

Incredible HDBaseT and Diverse Connectivity



Connect with virtually any system including HDBaseT, SDI, DVI-D, HDMI, VGA, BNC and LAN connectivity. Cutting-edge HDBaseT technology means just one single CAT-5/6 cable carries Full HD video, audio, network and control commands up to 100 meters to accommodate large venues. No need for additional cables, signal repeaters or added labour.

ADVANCED BUILT-IN FUCTIONS

NEW NFC Technology

Shorten kitting time with Epson Projector Config Tool App* & NFC function. Customisation of settings of the PU2000/1000 series projectors can be done up to 100 units as a batch. Specifically designed for rental and stage, SI and IT managers, the projector's inventory data can be easily checked and collected instantaneously by simply tapping with a mobile phone without having to turn on the projector.

**Epson Projector Config Tool App is available on iOS11 and Android 8.0*



Edge Blending

Enhance the experience with seamless panoramic, multi-screen images that blend edges by matching colour and brightness perfectly, even in areas that overlap.

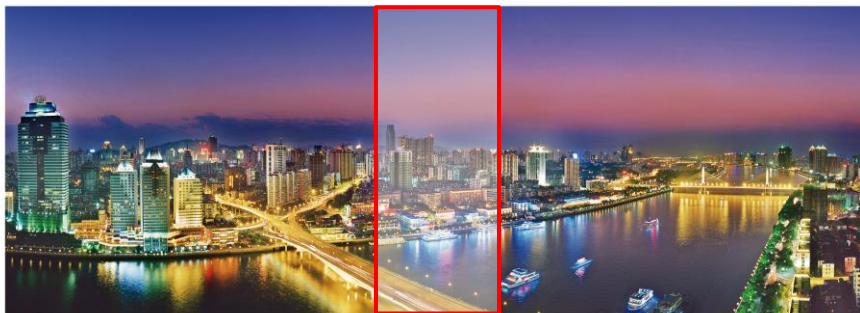

Point Correction

Make smooth adjustments of distorted projection images by shifting each of the points laid out on the grid pattern.



For further information please visit www.channel.epson.com.au



Arc Correction

Using arc correction, you can adjust each side of a projected image in an arch or barrel-shaped way, making it easier than ever to get a perfectly rectangular image.

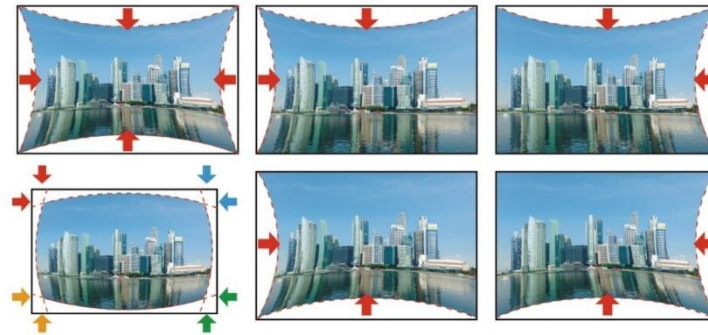

Colour Uniformity

Keep images consistent and maintain images that have become uneven over time between multiple projectors with manual colour correction function.

Corner Wall and Curved Surface Projection

Quickly and precisely correct any vertical or horizontal image distortion with Epson's curved surface and corner wall projection. These features allow for greater flexibility when choosing a projection surface. Enhance your viewers experience by projecting your content in a unique environment with ease.



Content Playback

The PU2000/1000 series projectors have an in-built content playback feature, allowing you to save videos and photos to USB flash memory and project them instantly without the need for a PC. Epson's dedicated software for digital signage applications complements the embedded feature for a cost-effective solution.



For instant content creation, the Epson Creative Projection App is available on iOS devices.



For scheduling, the Epson Content Management software is available for planning and execution.

ADVANCED INSTALLATION SOFTWARE

Epson Projector Professional Tool

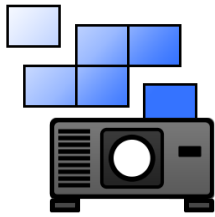

Setup multiple projectors straight out of the box with new large venue application software. Epson Professional tool allows you to adjust and control images projected on a network with high-end projector setup features such as colour uniformity calibration, geometry correction, image layout adjustment, lens control and edge blending. Exclusively bundled to Epson laser projectors, large scale presenting has become much easier and flexible with automation.

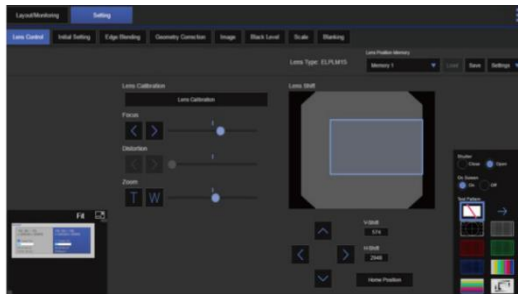
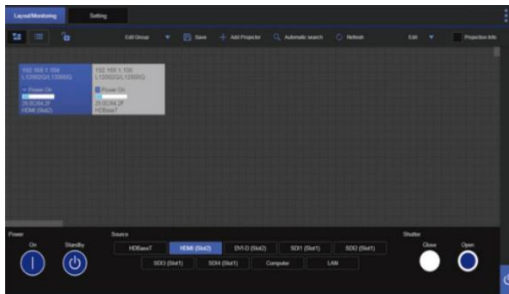

NEW Epson Projector Professional Tool x ELPEC01 support

Pair an ELPEC01 external camera with an EB-PU2000/1000 series projector to enable automation for geometry correction and screen matching. Powered by Epson Projector Professional Tool software, the set up for tiling and stacking of multiple projectors is quicker and easier than ever before.



EB-PU2000/1000 series with ELPEC01 lens attached

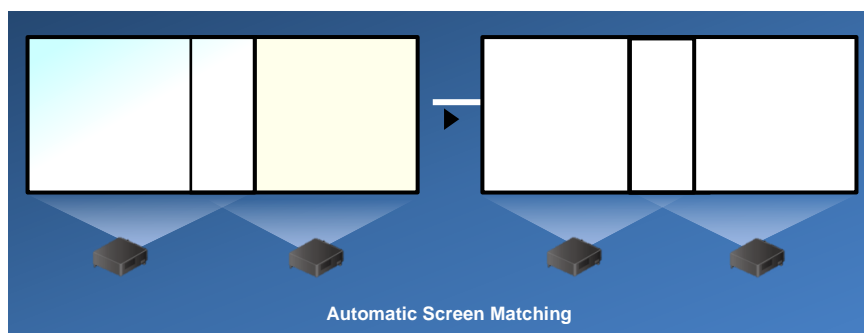
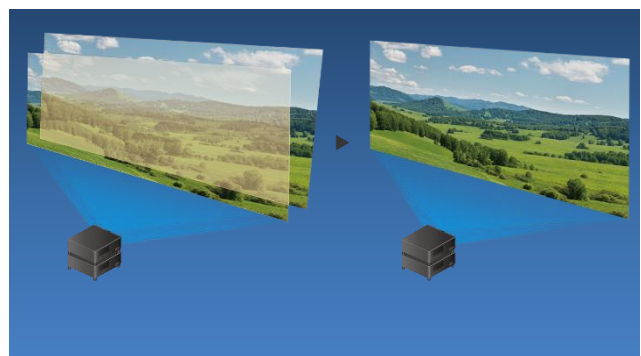
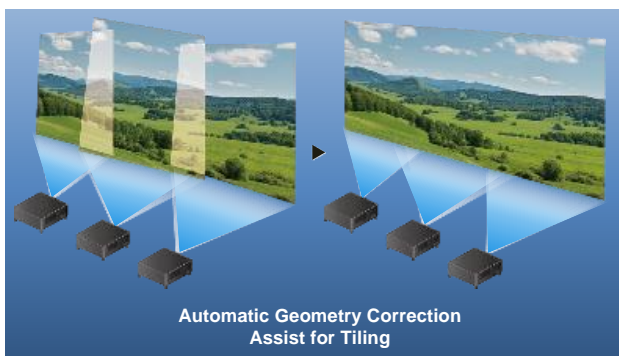

For further information please visit www.channel.epson.com.au



NEW Epson Projector Config Tool App

Exclusively available with the EB-PU2000/1000 series, Epson Projector Config Tool App* can save time on communication. Powered by NFC technology, projector information can be imported, exported for kitting preparation and confirmation. Installers, SI specialist, end customer, service team, repair team and rental & stage operators can now save time and effort, requiring as little as 7 minutes to collect the data out in the field on an iOS or Android device.



**Epson Projector Config Tool App is available on iOS11 and Android 8.0*

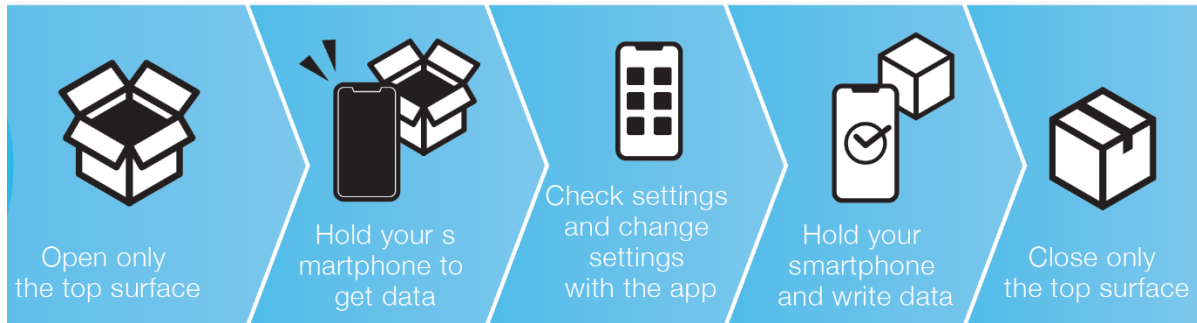

Epson Creative Projection App



With Epson Creative Projection app, you can create original, dazzling content to enliven rooms, product displays, and spaces around you, anytime and anywhere. Available on iOS devices, such as iPhone and iPad, content can be previewed while projecting and editing content at the same time.

With extensive preloaded templates, freely arrange and combine materials in the app any way you like. From simply uploading photos and movies from a mobile device to making animated visual effects, instantly make your display content come to life without requiring a PC.

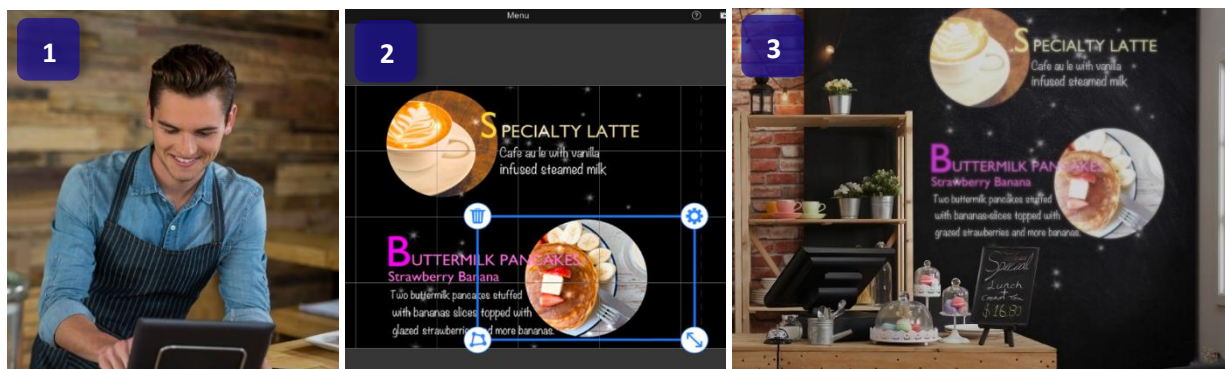

For further information please visit www.channel.epson.com.au



Epson Content Management Software



With Epson Content Management software, you can easily create playlists for signage content from a PC or a laptop. The ability to set schedules and register the shape filter settings gives you advanced control such as synchronised playback.

Key features of the software include:

- Creating playlists
- Adding visual effects
- Setting up remote shortcuts
- Applying custom filters
- Scheduling playlists



DICOM Simulation Mode

DICOM (Digital Imaging and Communication in Medicine) is a standard for handling, storing, printing and transmitting medical imaging information. The projector's DICOM Simulation Mode enables users to reproduce images with an advanced grayscale level that simulates DICOM Part 14. This mode is ideal for viewing grayscale medical images, such as X-rays for training and educational purposes.

Collaborative presenting – iProjection Software

Multiple users can connect simultaneously to one projector using Epson iProjection software which allows you to display four individual PC screens simultaneously over the network (wired or wireless), with up to 50 users connected to the same projector. This feature is a great tool for meetings or classroom projects where multiple users want to present and compare their screens.



Simple control – Epson Projector Management Software

Use features such as Epson Projector Management software to monitor and control projectors, with fleet control across a network or on a web browser to keep track of up to 2,000 projectors. The latest models feature a newly designed OSD Control Pad function that shows a representation of lens conditions on a smart device.

ADVANCED INSTALLATION ACCESSORIES

Ultra-Short Throw Lens

The ELPLX01S is a UST lens can produce images from 100 inches to a massive 1000 inches at a throw distance of 0.74m – 3.1m respectively and has a lens shift of +17% vertical and $\pm 10\%$ horizontally for added flexibility. The UST lens is also available in white.

(EB-PU2010B/W model is compatible with ELPLX02S. Lens shift range of ELPLX02S: +20% vertically, $\pm 15\%$ horizontally. Please refer to lens compatibility chart)

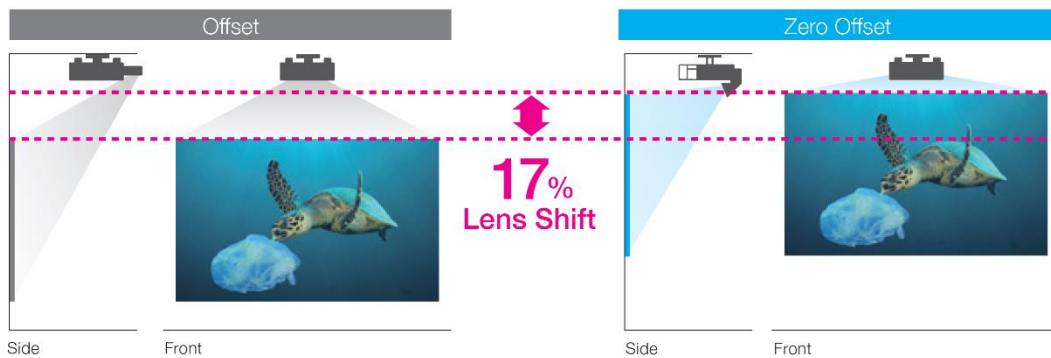

Eleven Optional Lenses

For added flexibility, the EB-PU2000/1000 series offers a total of eleven lenses, including middle, wide, long, short and ultra-short throw that allow users to choose the lens most suited for their environment. A quick-release lever allows for a fast, easy lens exchange.

4K Ready Optional Lens

A wide range of optional lenses are available for the EB-PU2000/1000 series to support any installation scenario. The optional lenses are all 4K compatible, and combined with the projector, deliver focused and sharp 4K Enhanced images.

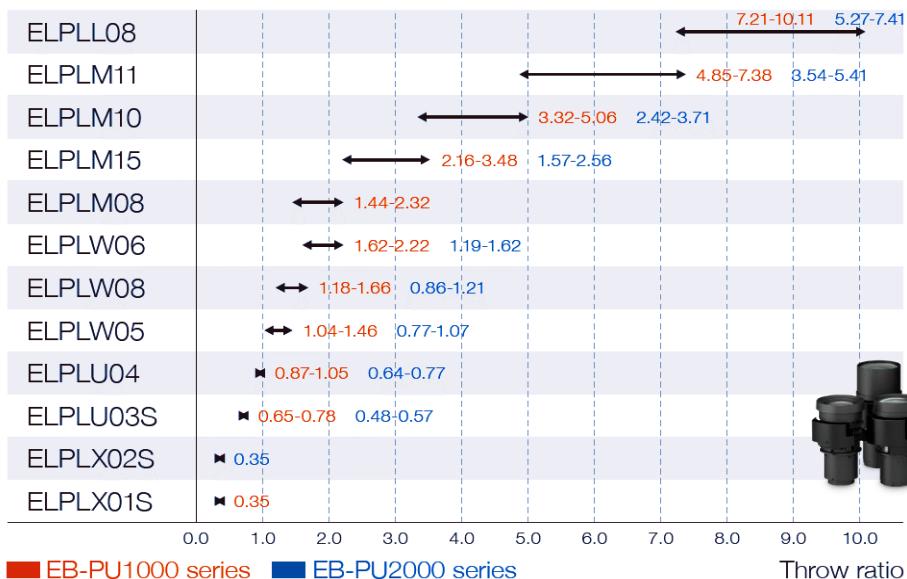

For further information please visit www.channel.epson.com.au



NEW Ceiling Mount ELPMB67 and Extension Pole ELPFP15

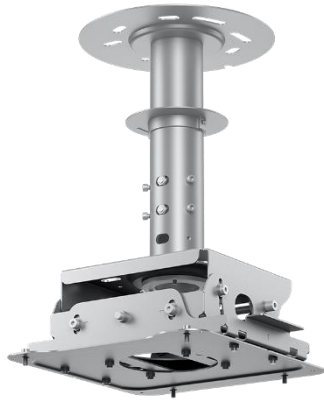

ELPMB67 + ELPFP15

ELPMB67 ceiling mount and ELPFP15 extension pole are lighter than the previous mount, giving you even more installation flexibility across the Epson laser projectors. Also, the ELPMB67 can accommodate wider vertical adjustment angle within + 5° / -15° range. Both mount and extension pole come in grey to easily integrate into any colour scheme.



ELPMB67



ELPMB67 + ELPFP15

NEW External Camera ELPEC01



ELPEC01

Attach an ELPEC01 external camera to the EB-PU2000/1000 series or ELPLX02/01 UST lens to enable a powerful installation capability. Compatible with Epson Professional Tool software and Epson Projector Management software, automate manual installation processes and enable remote camera access when required.



ELPEC01 with projector



ELPEC01 with UST lens

NEW External Air filter ELPAF63

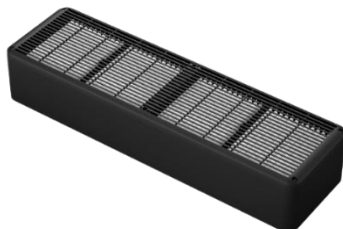

ELPAF63

Exclusively designed for the EB-PU2000/1000 series, external air filter ELPAF63 extends the brightness level and protects the projector's internal optical engine from external dust particles. Attaching the ELPAF63 gives an equivalent protection to sealing an optical engine structure, so that the projector's performance is not compromised in an environment that contains high degree of particulates.



ELPAF63 with projector

PRODUCT CODES AND PRICING

Projectors

PRODUCT CODE	DESCRIPTION	RRP (INC GST)
V11HA34953BU	EB-PU1007W	\$9,799
V11HA34853BU	EB-PU1007B	\$9,799
V11HA33953BU	EB-PU1008W	\$11,819
V11HA33853BU	EB-PU1008B	\$11,819
V11HA52953BU	EB-PU2010W	\$17,699
V11HA52853BU	EB-PU2010B	\$17,699

Lens

PRODUCT CODE	DESCRIPTION	RRP (INC GST)
V12H004X0A	NEW ELPLX01S Ultra Short Throw Zoom Lens	\$10,199
V12H004X0B	NEW ELPLX02S Ultra Short Throw Zoom Lens	\$13,719
V12H004UA3	ELPLU03S Short Throw Lens 1	\$3,899
V12H004U04	ELPLU04 Short Throw Lens 2	\$3,699
V12H004M08	ELPLM08 Middle Throw Zoom Lens 1	\$599
V12H004M0F	ELPLM15 Middle Throw Zoom Lens 2	\$2,099
V12H004M0A	ELPLM10 Middle Throw Zoom Lens 3	\$2,099
V12H004M0B	ELPLM11 Middle Throw Zoom Lens 4	\$2,099
V12H004W05	ELPLW05 Wide Throw Zoom Lens 1	\$2,099
V12H004W06	ELPLW06 Wide Throw Zoom Lens 2	\$4,399
V12H004W08	ELPLW08 Wide Throw Zoom Lens 3	\$12,683
V12H004L08	ELPLL08 Long Throw Zoom Lens	\$4,399

Accessories

PRODUCT CODE	DESCRIPTION	RRP (INC GST)
V13H134A46	ELPAF46 Replacement Filter	\$95
V13H134AD0	NEW ELPAF63 External Air filter	\$529
V12HA46010	NEW ELPEC01 External Camera	\$519
V12HA54010	NEW ELPMB67 Ceiling Mount	\$399
V12HA55010	NEW ELPFP15 Extension Pole 460 – 680 mm	\$249
V12H547053	HDBaseT Transmitter	\$399
V12H005A01	ELPAP11 Wireless LAN Adaptor	\$149

MODEL OVERVIEW

Model	NEW EB-PU1007W EB-PU1007B	NEW EB-PU1008W EB-PU1008B	NEW EB-PU2010W EB-PU2010B	EB-L1060U EB-L1065U	EB-L1070U EB-L1075U
Case Colour	White/Black	White/Black	White/Black	White/Black	White/Black
White Light Output	7,000 lms	8,500 lms	10,000 lms	6,000 lms	7,000 lms
Colour Light Output	7,000 lms	8,500 lms	10,000 lms	6,000 lms	7,000 lms
Display Technology	3LCD	3LCD	3LCD	3LCD	3LCD
Native Resolution	WUXGA	WUXGA	WUXGA	WUXGA	WUXGA
4K enhancement	✓	✓	✓	✓	✓
Aspect Ratio	16:10	16:10	16:10	16:10	16:10
Contrast Ratio	2,500,000:1	2,500,000:1	2,500,000:1	2,500,000:1	2,500,000:1
Keystone	V ±45° H ±30°	V ±45° H ±30°	V ±45° H ±30°	V ±45° H ±30°	V ±45° H ±30°
Lens Shift (Powered)	V ±67% H ±30%	V ±67% H ±30%	V ±60% H ±18%	V ±67% H ±30%	V ±67% H ±30%
Zoom Ratio	1 - 1.6	1 - 1.6	1 - 1.6	1 - 1.6	1 - 1.6
Wireless LAN	Optional	Optional	Optional	Optional	Optional
Edge Blending	✓	✓	✓	✓	✓
Curved Surface	✓	✓	✓	✓	✓
Corner Wall Projection	✓	✓	✓	✓	✓
Frame Interpolation	✓	✓	✓	✓	✓
HDBaseT	✓	✓	✓	✓	✓
Scaling	✓	✓	✓	✓	✓
NFC	✓	✓	✓	✗	✗
External Air Filter ELPAF63 support	✓	✓	✓	✗	✗
External Camera ELPEC01 support	✓	✓	✓	✗	✗
HDR10	✓	✓	✓	✗	✗
Gamma Correction	✓	✓	✓	✗	✗
Art-Net	✓	✓	✓	✗	✗
SDI in/out	✗	✗	✓	✗	✗
Wireless LAN Enterprise Security	✓	✓	✓	✓	✓
AMX Device Discovery	✓	✓	✓	✓	✓
Extron IP Link	✓	✓	✓	✓	✓
Extron XTP	✓	✓	✓	✓	✓
Crestron Integrated Partner / RoomView	✓	✓	✓	✓	✓
Content playback	✓	✓	✓	✓	✓
Creative Projection App Support	✓	✓	✓	✓	✓
Content Management Software Support	✓	✓	✓	✓	✓
Projector Professional tool support	✓	✓	✓	✓	✓
Projector Config Tool App Support	✓	✓	✓	✗	✗
Optional Lenses*	11	11	10	11	11
Dimensions excluding feet and back cable cover (D x W x H mm)	436 x 545 x 164	436 x 545 x 164	436 x 545 x 164	436 x 545 x 164	436 x 545 x 164
Weight excluding lens (Kg)	16.3	16.3	16.8	15.6	15.6
Fan noise (Normal/Eco)	34/30 dB	36/30 dB	37/30 dB	34/30 dB	36/30 dB
Power consumption: LD on	366 W	452 W	452 W	346 W	416 W
Power consumption: Standby	2 W	2 W	2 W	2 W	2 W
Required power supply	10A	10A	10A	10A	10A

*Please refer to lens compatibility chart

For further information please visit www.channel.epson.com.au



Lens Compatibility Chart

Lens	Description	Zoom Ratio	PU2010W PU2010B Throw Ratio	PU1080W/ PU1080B/ PU1070W/ PU1070B Throw Ratio	L1060U/ L1065U/ L1070U/ L1075U Throw Ratio
ELPLX01S	Ultra Short Throw Lens 1	-		0.35	0.35
ELPLX02S	Ultra Short Throw Lens 2	-	0.35		
ELPLU03S	Short Throw Lens 1	1 - 1.2	0.48 - 0.57	0.65 - 0.78	0.65 - 0.78
ELPLU04	Short Throw Lens 2	1 - 1.2	0.64 - 0.77	0.87 - 1.05	0.87 - 1.05
ELPLM08	Middle Throw Lens 1	1 - 1.6		1.44 - 2.32	1.44 - 2.32
ELPLM10	Middle Throw Lens 3	1 - 1.5	2.42 - 3.71	3.32 - 5.06	3.32 - 5.06
ELPLM11	Middle Throw Lens 4	1 - 1.5	3.54 - 5.41	4.85 - 7.38	4.85 - 7.38
ELPLM15	Middle Throw Lens 5	1 - 1.6	1.57 - 2.56	2.16 - 3.48	2.16 - 3.48
ELPLW05	Wide Throw Lens 1	1 - 1.4	0.77 - 1.07	1.04 - 1.46	1.04 - 1.46
ELPLW06	Wide Throw Lens 2	1 - 1.4	1.19 - 1.62	1.62 - 2.22	1.62 - 2.22
ELPLW08	Wide Throw Lens 3	1 - 1.4	0.86 - 1.21	1.18 - 1.66	1.18 - 1.66
ELPLL08	Long Throw Lens	1 - 1.4	5.27 - 7.41	7.21 - 10.11	7.21 - 10.11

CONNECTIVITY PANEL

EB-PU1070W/B and EB-PU1080W/B



EB-PU2010W/B



For further information please visit www.channel.epson.com.au